

版本 REV.	日期 DATE	ECN NO.	变更内容 DESCRIPTION	制图 DRAWN

SPECIFICATIONS

- 1、Current Rating: 2A AC, DC
- 2、Voltage Rating: 125V AC, DC
- 3、Temperatuer Range: -40℃~+105℃
- 4、Contact Resistance: 20mΩ Max
- 5、Insulation Resistance: 1000MΩ Min
- 6、Withstanding Voltang: 1000V AC/minute
- 7、Material: Wafer PA66, UL94V-0  
PIN Brass Tin-plated

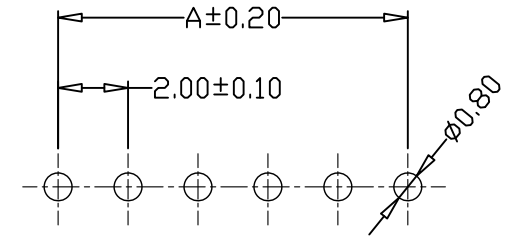
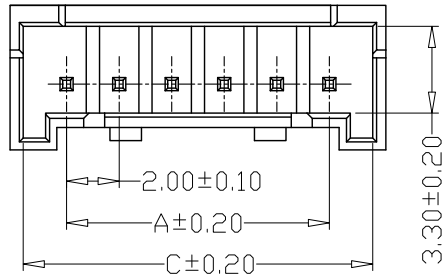

PCB LAYOUT

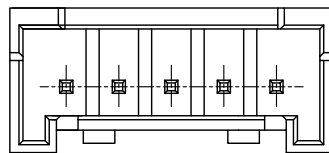
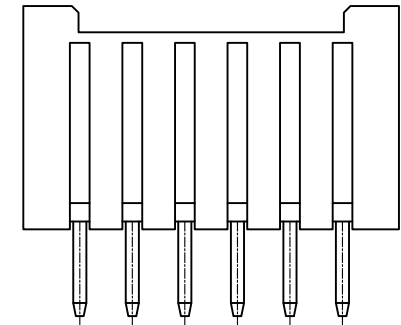
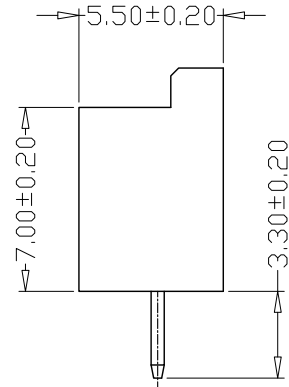
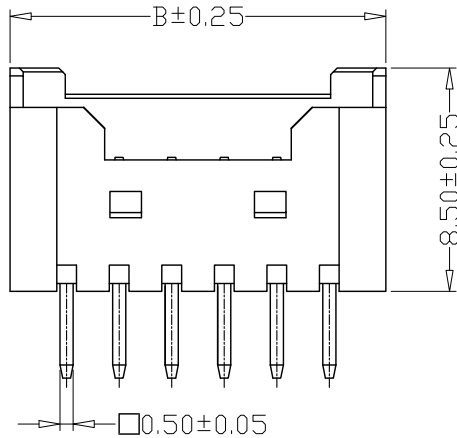

5A

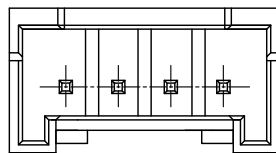

4A

PIN	尺寸 (mm)		
	A	B	C
-04A	6.00	10.30	9.30
-05A	8.00	12.30	11.30
-06A	10.00	14.30	13.30

GENERAL TOLERANCE		制图 Mapping	张迎春 2022、09、10	料号 PART NO.	A20007-nA		版本 REV.	A
X.±0.25	X.°±2°	审核 Audit	钱岳生 2022、09、10	品名 TITLE	HY-200R直针 WAFER DIP TYPE		页次 SHEET	1/1
.X±0.25	.X°±1°	核准 Approved	张名 2022、09、11	客户料号 CUTM. NO.				
.XX±0.15	.XX°±0.5°	单位 Units	MM	比例 SCALE	1:1			
.XXX±0.10	.XXX°±0.5°	YueQing HongYi Electronics Co., Ltd						

乐清市宏一电子有限公司  
YueQing HongYi Electronics Co., Ltd

版本 REV.	日期 DATE	ECN NO.	变更内容 DESCRIPTION	制图 DRAWN

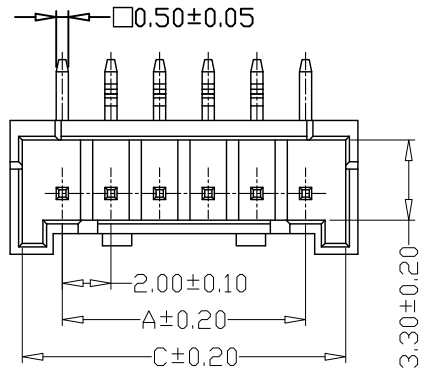

SPECIFICATIONS

- 1、Current Rating: 2A AC, DC
- 2、Voltage Rating: 125V AC, DC
- 3、Temperatuer Range: -40°C~+105°C
- 4、Contact Resistance: 20mΩ Max
- 5、Insulation Resistance: 1000MΩ Min
- 6、Withstanding Voltang: 1000V AC/minute
- 7、Material: Wafer PA66, UL94V-0  
PIN Brass Tin-plated

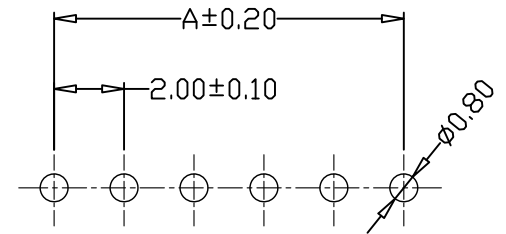

PCB LAYOUT

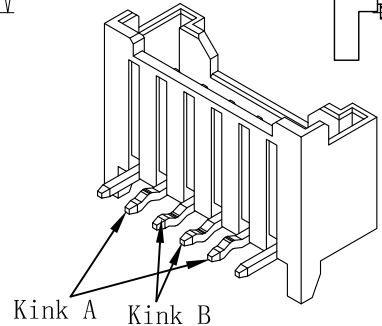
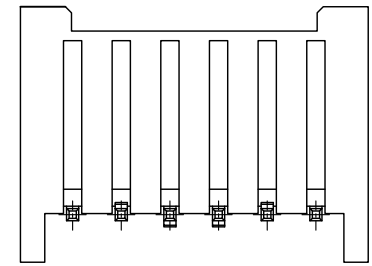
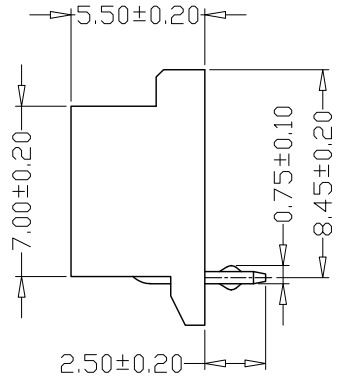
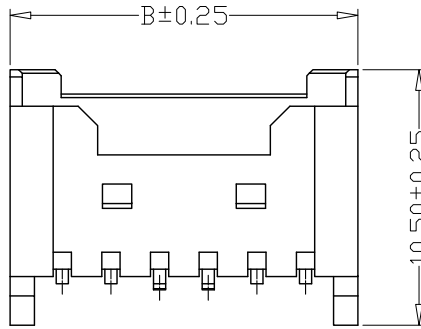

PIN	尺寸 (mm)		
	A	B	C
-04AW	6.00	10.30	9.30
-05AW	8.00	12.30	11.30
-06AW	10.00	14.30	13.30

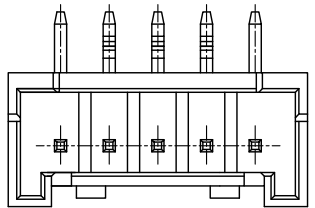

5A

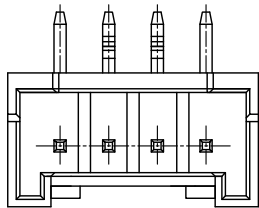

4A

GENERAL TOLERANCE		制图 Mapping	张迎春 2022、09、10		料号 PART NO.	A20007-nAW		版本 REV.	A
X.±0.25	X.°±2°	审核 Audit	钱岳生 2022、09、10		品名 TITLE	HY-200R弯针 WAFER DIP TYPE		页次 SHEET	1/1
.X±0.25	.X°±1°	核准 Approved	张名 2022、09、11		客户料号 CUTM. NO.				
.XX±0.15	.XX°±0.5°	单位 Units	MM	比例 SCALE	1:1				
.XXX±0.10	.XXX°±0.5°								

乐清市宏一电子有限公司  
YueQing HongYi Electronics Co., Ltd